

ANKA™

Hose Nozzles



Pipe Unions



Hose Tails



Swivels



Check Valves

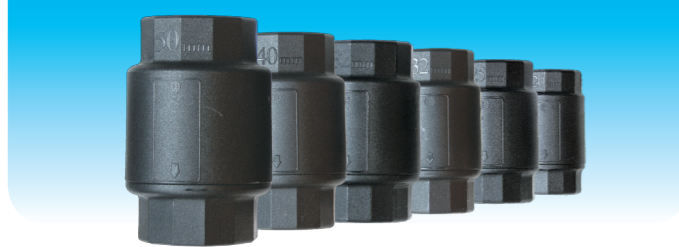

Quick-Lock Couplings



Foot Valves



Air Vac Breakers



Screens



DEMAND **ANKA**
BLUE NUT
FITTINGS FOR POLYTHENE PIPE

Now you can forget
about hand-tight
and make it
ANKA TIGHT



ANKA Pipe Fittings are used extensively in New Zealand agricultural, horticultural, irrigation & industry. Manufactured from high grade glass fibre reinforced nylon, these fittings are strong and lightweight. Designed to fit a large range of New Zealand polythene pipes, Australian Rural B, Irish Imperial and a variety of flexible hoses, both suction and pressure.



leading with knowledge

Auckland Ph: 09 415 6151 Email: info@hydroflow.co.nz
Christchurch Ph: 03 341 1048 Email: chch@hydroflow.co.nz

Distributed by

Hydroflow
LEADING WITH KNOWLEDGE

Hydroflow 011-30

DEMAND **ANKA**
BLUE NUT
FITTINGS FOR POLYTHENE PIPE

Distributed by

Hydroflow
LEADING WITH KNOWLEDGE

- Extremely robust **BLUE NUT** that can be tightened way beyond hand-tight for a better seal.
- **BLUE NUT** has no sharp edges making tightening it to hand tight a breeze.
- **BLUE NUT** makes identification and in field location much easier.
- The glass fibre fill added to the **BLUE NUT** plastic in manufacture, gives incredibly strong gripping ridges for mechanical tightening.

- Once pipe is pushed over the sealing barbs, a ridge is created allowing the **BLUE NUT** to be tightened

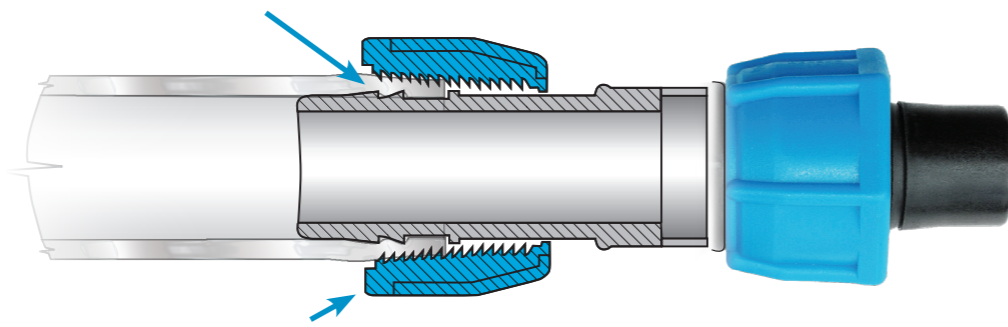

- The captive **BLUE NUT** is permanently held onto the fitting body so it can't become separated and lost.

ANKA polythene pipe fittings are quick and easy to fit. Simply push the pipe over the barbs up to the "stop" then tighten the **BLUE NUT**. The double barb gives a large surface area for the pipe to grip onto. In most situations **ANKA** Fittings can be fitted cold to pipe. The **ANKA** Double Barb is a feature of the 25mm-50mm fittings.

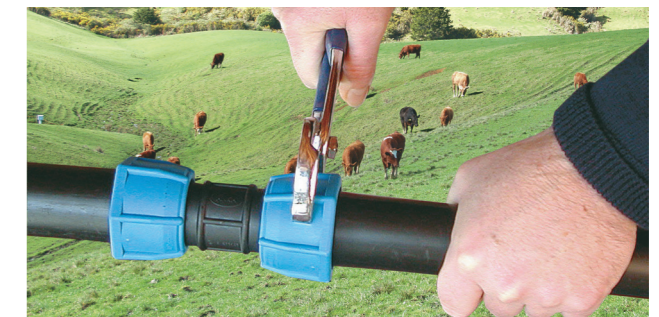



Step 1. Push the **ANKA BLUE NUT** fitting onto pipe.

Step 2. Tighten the **BLUE NUT** by hand then wrench.

AFB	Anka Female Bend	mm	in
		15	1/2
		20	3/4
		25	1
		32	1 1/4
		40	1 1/2
		50	2

ARFB	Anka Reducing Female Bend	mm	in
		20 x 15	3/4 x 1/2
		20 x 25	3/4 x 1
		25 x 20	1 x 3/4
		32 x 25	1 1/4 x 1
		40 x 32	1 1/2 x 1 1/4
		50 x 40	2 x 1 1/2

AT	Anka Tee	mm	in
		15	1/2
		20	3/4
		25	1
		32	1 1/4
		40	1 1/2
		50	2

AFT	Anka Female Tee	mm	in
		15	1/2
		20	3/4
		25	1
		32	1 1/4
		40	1 1/2
		50	2

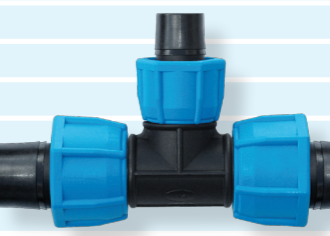
ART	Anka Reducing Tee	mm	in
		15 x 20	1/2 x 3/4
		20 x 15	3/4 x 1/2
		20 x 25	3/4 x 1
		25 x 15	1 x 1/2
		25 x 20	1 x 3/4
		32 x 20	1 1/4 x 3/4
		32 x 25	1 1/4 x 1
		40 x 25	1 1/2 x 1
		40 x 32	1 1/2 x 1 1/4
		50 x 32	2 x 1 1/4
		50 x 40	2 x 1 1/2

AMB	Anka Male Bend	mm	in
		15	1/2
		20	3/4
		25	1
		32	1 1/4
		40	1 1/2
		50	2

ARMB	Anka Reducing Male Bend	mm	in
		15 x 20	1/2 x 3/4
		20 x 15	3/4 x 1/2
		20 x 25	3/4 x 1
		25 x 20	1 x 3/4

AMBL	Anka Male Bend Long	mm	in
		15	1/2
		20	3/4
		25	1

ARMBL	Anka Reducing Male Bend Long	mm	in
		15 x 20	1/2 x 3/4
		20 x 15	3/4 x 1/2
		20 x 25	3/4 x 1
		25 x 20	1 x 3/4

AB	Anka Bend	mm	in
		15	1/2
		20	3/4
		25	1
		32	1 1/4
		40	1 1/2
		50	2

AFC	Anka Female Coupling	mm	in
		15	1/2
		20	3/4
		25	1
		32	1 1/4
		40	1 1/2
		50	2

ARFC	Anka Reducing Female Coupling	mm	in
		20 x 15	3/4 x 1/2
		25 x 20	1 x 3/4
		32 x 25	1 1/4 x 1
		40 x 32	1 1/2 x 1 1/4
		50 x 40	2 x 1 1/2

ASC	Anka Straight Coupling	mm	in
		15	1/2
		20	3/4
		25	1
		32	1 1/4
		40	1 1/2
		50	2

ARC	Anka Reducing Coupling	mm	in
		20 x 15	3/4 x 1/2
		25 x 15	1 x 1/2
		25 x 20	1 x 3/4
		32 x 20	1 1/4 x 3/4
		32 x 25	1 1/4 x 1
		40 x 25	1 1/2 x 1
		40 x 32	1 1/2 x 1 1/4
		50 x 40	2 x 1 1/2

AU	Anka Union	mm	in
		20 x 20	3/4 x 3/4
		25 x 25	1 x 1
		32 x 32	1 1/4 x 1 1/4

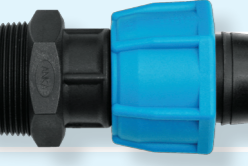
AMC	Anka Male Coupling	mm	in
		15	1/2
		20	3/4
		25	1
		32	1 1/4
		40	1 1/2
		50	2

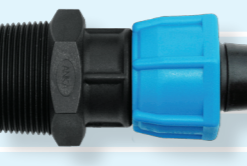
ARMC	Anka Reducing Male Coupling	mm	in
		15 x 20	1/2 x 3/4
		20 x 15	3/4 x 1/2
		20 x 25	3/4 x 1
		25 x 15	1 x 1/2
		25 x 20	1 x 3/4
		32 x 20	1 1/4 x 3/4
		32 x 25	1 1/4 x 1

ASCL	Anka Straight Coupling Long	mm	in
		15	1/2
		20	3/4
		25	1

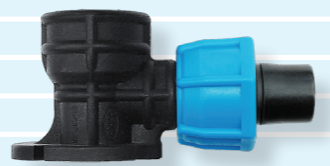
ABE	Anka Bracket Elbow	mm	in
		15	1/2
		15 x 20	1/2 x 3/4
		20	3/4
		20 x 15	3/4 x 1/2
		20 x 25	3/4 x 1

AMT	Anka Male Tee	mm	in
		15 x 20	1/2 x 3/4
		20 x 20	3/4 x 3/4